



TDA7575PD

MULTIFUNCTION DUAL BRIDGE POWER AMPLIFIER WITH INTEGRATED DIGITAL DIAGNOSTICS

- DMOS POWER OUTPUT
- NON-SWITCHING HI-EFFICIENCY
- SINGLE-CHANNEL 1Ω DRIVING CAPABILITY
- HIGH OUTPUT POWER CAPABILITY 2x28W/4Ω @ 14.4V, 1KHZ, 10% THD, 2x40W/4Ω EIAJ
- MAX. OUTPUT POWER 2x75W/2Ω, 1x150W/1Ω
- SINGLE-CHANNEL 1Ω DRIVING CAPABILITY
 - 84W UNDISTORTED POWER
 - FULL I²C BUS DRIVING WITH 4 ADDRESS POSSIBILITIES:
 - ST-BY, PLAY/MUTE, GAIN 12/26dB, FULL DIGITAL DIAGNOSTIC
- POSSIBILITY TO DISABLE THE I²C
- DIFFERENTIAL INPUTS
- FULL FAULT PROTECTION
- DC OFFSET DETECTION
- TWO INDEPENDENT SHORT CIRCUIT PROTECTIONS
- CLIPPING DETECTOR PIN WITH SELECTABLE THRESHOLD (2%/10%)
- ST-BY/MUTE PINS

DESCRIPTION

The TDA7575PD is a new BCD technology DUAL BRIDGE type of car radio amplifier in PowerSO36 package specially intended for car radio applications. Thanks to the DMOS output stage the TDA7575PD

MULTIPOWER BCD TECHNOLOGY

MOSFET OUTPUT POWER STAGE

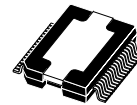

PowerSO36 (Slug up)

ORDERING NUMBER: TDA7575PD

has a very low distortion allowing a clear powerful sound. Among the features, its superior efficiency performance coming from the internal exclusive structure, makes it the most suitable device to simplify the thermal management in high power sets. The dissipated output power under average listening condition is in fact reduced up to 50% when compared to the level provided by conventional class AB solutions.

This device is equipped with a full diagnostic array that communicates the status of each speaker through the I²C bus. The TDA7575PD has also the possibility of driving loads down to 1Ω paralleling the outputs into a single channel. It is also possible to disable the I²C and control the TDA7575PD by means of the usual ST-BY and MUTE pins.

BLOCK DIAGRAM

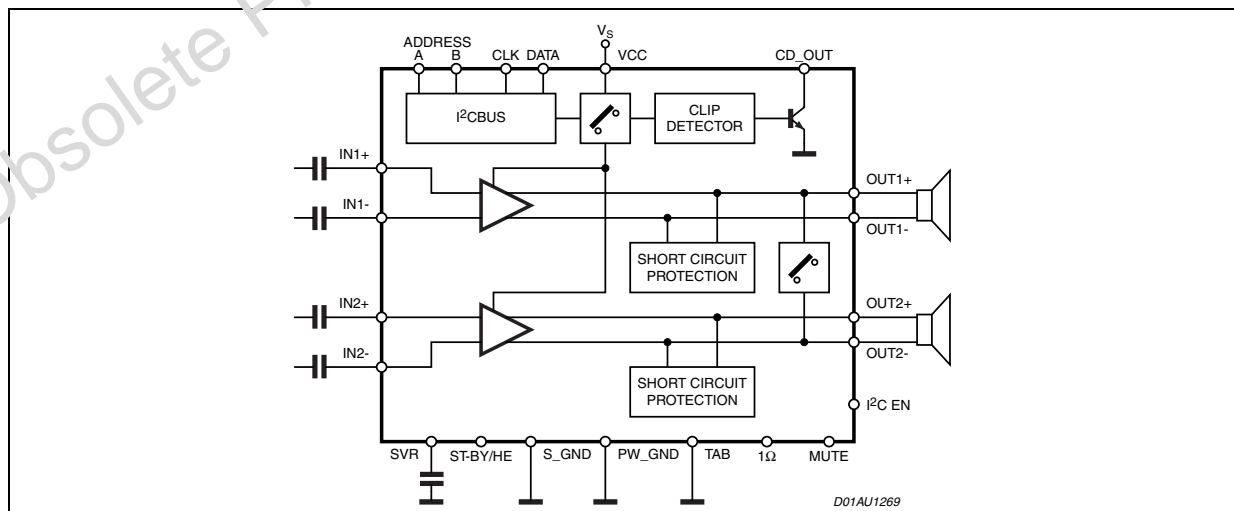

TDA7575PD

PIN CONNECTION (Top view)

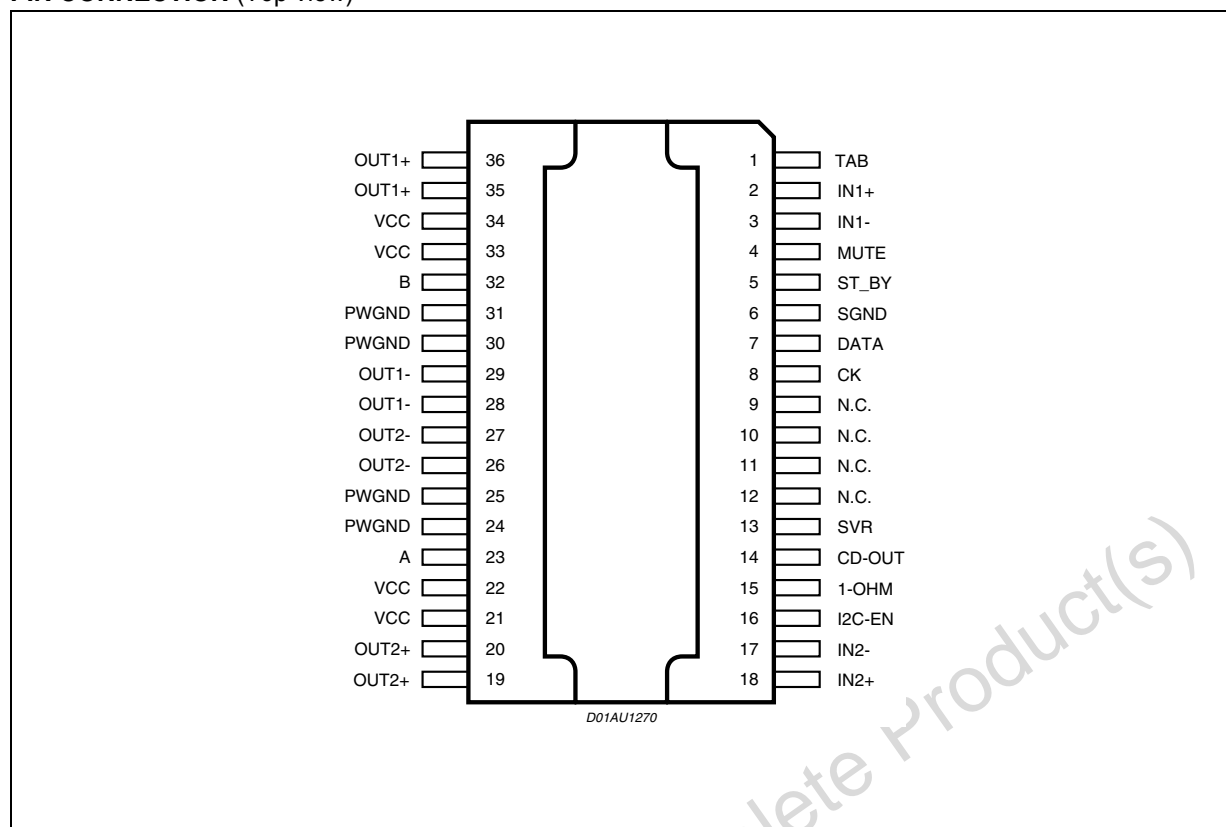

ABSOLUTE MAXIMUM RATINGS

Symbol	Parameter	Value	Unit
V_{op}	Operating Supply Voltage	18	V
V_S	DC Supply Voltage	28	V
V_{peak}	Peak Supply Voltage (for $t = 50ms$)	50	V
V_{CK}	CK pin Voltage	6	V
V_{DATA}	Data Pin Voltage	6	V
I_o	Output Peak Current (not repetitive $t = 100ms$)	8	A
I_o	Output Peak Current (repetitive $f > 10Hz$)	6	A
P_{tot}	Power Dissipation $T_{case} = 70^\circ C$	86	W
T_{stg}, T_j	Storage and Junction Temperature	-55 to 150	$^\circ C$

THERMAL DATA

Symbol	Parameter	Value	Unit
$R_{th\ j-case}$	Thermal Resistance Junction-case	Max 1	$^\circ C/W$

ELECTRICAL CHARACTERISTICS: ($V_S=14.4V$; $f=1KHz$; $R_L=4\Omega$; $T_{amb}= 25^\circ C$ unless otherwise specified)

Symbol	Parameter	Test Condition	Min.	Typ.	Max.	Unit
POWER AMPLIFIER						
V_S	Supply Voltage Range		8		18	V
I_d	Total Quiescent Drain Current		50	130	200	mA
P_o	Output Power	EIAJ ($V_S = 13.7V$)	35	40		W
		THD = 10%	25	28		W
		THD = 1%; BTL MODE		22		W
		$R_L = 2\Omega$; EIAJ ($V_S = 13.7V$)	60	65		W
		$R_L = 2\Omega$; THD 10%	45	50		W
$R_L = 2\Omega$; THD 1%		37		W		
$R_L = 2\Omega$; MAX POWER		70	75		W	
THD	Total Harmonic Distortion	Single channel configuration (1Ω pin >2.5V); $R_L = 1\Omega$; EIAJ ($V_S = 13.7V$)	125	130		W
		THD 3%	80	84		W
		MAX POWER	140	150		W
		$P_O = 1-12W$; STD MODE		0.03	0.1	%
$P_O = 1-2W$ HE MODE;		0.03	0.1	%		
$P_O = 4-8W$ HE MODE;		0.5		%		
$P_O = 1-12W$, $f = 10kHz$		0.15	0.5	%		
$R_L = 2$; HE MODE; $P_o = 3W$		0.03	0.5	%		
Single channel configuration (1Ω pin >2.5V); $R_L = 1$; $P_O = 4-30W$		0.02	0.1	%		
C_T	Cross Talk	$R_g = 600\Omega$; $P_O = 1W$	60	75		dB
R_{IN}	Input Impedance		60	100	130	K Ω
G_{V1}	Voltage Gain 1 (default)		25	26	27	dB
ΔG_{V1}	Voltage Gain Match 1		-1	0	1	dB
G_{V2}	Voltage Gain 2		11	12	13	dB
ΔG_{V2}	Voltage Gain Match 2		-1	0	1	dB
E_{IN1}	Output Noise Voltage Gain 1	$R_g = 600\Omega$; $G_v = 26dB$ filter 20 to 22kHz		40	60	μV
E_{IN2}	Output Noise Voltage Gain 2	$R_g = 600\Omega$; $G_v = 12dB$ filter 20 to 22kHz		15	25	μV
SVR	Supply Voltage Rejection	$f = 100Hz$ to $10kHz$; $V_r = 1Vpk$; $R_g = 600\Omega$	50	60		dB
BW	Power Bandwidth	(-3dB)	100			KHz
A_{SB}	Stand-by Attenuation		90	100		dB
I_{SB}	Stand-by Current Consumption			2	20	μA
A_M	Mute Attenuation		80	90		dB
V_{OS}	Offset Voltage	Mute & Play	-45	0	45	mV
V_{AM}	Min. Supply Mute Threshold		7	7.5	8	V
CMRR	Input CMRR	$V_{CM} = 1Vpk-pk$; $R_g = 0 \Omega$	50	60		dB

ELECTRICAL CHARACTERISTICS: (continued)

Symbol	Parameter	Test Condition	Min.	Typ.	Max.	Unit
V _{MC}	Maximum common mode input level	f = 1kHz			1	V _{rms}
SR	Slew Rate		1.5	4		V/μs
ΔV _{PM}	Mute/Unmute Transient	A-weighted	-100	0	100	mVpp
ΔV _{TO}	Mute/Stand-by Transient	A-weighted	-100	0	100	mVpp
T _{ON}	Turn on Delay	D2 (IB1) 0 to 1		15	40	ms
T _{OFF}	Turn off Delay	D2 (IB1) 1 to 0		15	40	ms
V _{OFF}	St-By pin for St-By		0		1.5	V
V _{SB}	St-By pin for standard bridge		3.5		5	V
V _{HE}	St-By pin for Hi-eff		7		18	V
I _O	St-By pin Current	1.5 < V _{stby/HE} < 18V	7	160	200	μA
	St-By Pin Current	V _{stby} < 1.5V	-10	0	10	μA
V _m	Mute pin voltage for mute mode		0		1.5	V
V _m	Mute pin voltage for play mode		3.5		18	V
I _m	Mute pin current (ST_BY)	V _{mute} = 0V, V _{stby} < 1.5V	-5	0	5	μA
I _m	Mute pin current (operative)	0V < V _{mute} < 18V, V _{stby} > 3.5V		65	100	μA
V _{I2C}	I2C pin voltage for I2C disabled		0		1.5	V
V _{I2C}	I2C pin voltage for I2C enabled		2.5		18	V
I _{I2C}	I2C pin current (stby)	0V < I2C EN < 18V, V _{stby} < 1.5V	-5	0	5	μA
I _{I2C}	I2C pin current (operative)	I2C EN < 18V, V _{stby} > 3.5V	7	11	15	μA
V _{1OHM}	1OHM pin voltage for 2ch mode		0		1.5	V
V _{1OHM}	1OHM pin voltage for 1ohm mode		2.5		18	V
I _{1OHM}	1OHM pin current (stby)	0V < 1OHM < 18V, V _{stby} < 1.5V	-5	0	5	μA
I _{1OHM}	1OHM pin current (operative)	1OHM < 18V, V _{stby} > 3.5V	7	11	15	μA
I _a	A Pin Voltage	Low logic level	0		1.5	V
I _a	A Pin Voltage	High logic level	2.5		18	V
I _a	A Pin Current (ST-BY)	0V < A < 18V, V _{stby} < 1.5V	-5	0	5	μA
I _a	A Pin Current (Operative)	A < 18V, V _{stby} > 3.5V	7	11	15	μA
I _b	B Pin Voltage	Low logic level	0		1.5	V
I _b	B Pin Voltage	High logic level	2.5		18	V
I _b	B Pin Current (ST-BY)	0V < B < 18V, V _{stby} < 1.5V	-5	0	5	μA
I _b	B Pin Current (Operative)	B < 18V, V _{stby} > 3.5V	7	11	15	μA
T _W	Thermal warning			150		°C
T _{PI}	Thermal Protection intervention			170		°C
I _{CDH}	Clip Pin High Leakage Current	CD off, 0V < V _{CD} < 5.5V	-15	0	15	μA

ELECTRICAL CHARACTERISTICS: (continued)

Symbol	Parameter	Test Condition	Min.	Typ.	Max.	Unit
I _{CDL}	Clip Pin Low Sink Current	CD on; V _{CD} < 300mV	1			mA
CD	Clip detect THD level	D0 (IB1) = 0	0.8	1.3	2.5	%
		D0 (IB1) = 1	5	10	15	%
(*) ST-BY Pin high enables I2C bus; ST-BY Pin low puts the device in ST-BY condition.(see "prog" for more details)						
TURN ON DIAGNOSTICS (Power Amplifier Mode)						
Pgnd	Short to GND det. (below this limit, the Output is considered in Short Circuit to GND)	Power Amplifier in st-by condition			1.2	V
Pvs	Short to Vs det. (above this limit, the Output is considered in Short Circuit to VS)		V _s -0.9			V
Pnop	Normal operation thresholds.(Within these limits, the Output is considered without faults).		1.8		V _s -1.5	V
Lsc	Shorted Load det.				0.5	Ω
Lop	Open Load det.		130			Ω
Lnop	Normal Load det.		1.5		70	Ω
TURN ON DIAGNOSTICS (Line Driver Mode)						
Pgnd	Short to GND det. (below this limit, the Output is considered in Short Circuit to GND)	Power Amplifier in st-by			1.2	V
Pvs	Short to Vs det. (above this limit, the Output is considered in Short Circuit to VS)		V _s -0.9			V
Pnop	Normal operation thresholds.(Within these limits, the Output is considered without faults).		1.8		V _s -1.5	V
Lsc	Shorted Load det.				1.5	Ω
Lop	Open Load det.		400			Ω
Lnop	Normal Load det.		4.5		200	Ω
PERMANENT DIAGNOSTICS (Power Amplifier Mode or Line Driver Mode)						
Pgnd	Short to GND det. (below this limit, the Output is considered in Short Circuit to GND)	Power Amplifier in Mute or Play condition, one or more short circuits protection activated			1.2	V
Pvs	Short to Vs det. (above this limit, the Output is considered in Short Circuit to VS)		V _s - 0.9			V
Pnop	Normal operation thresholds.(Within these limits, the Output is considered without faults).		1.8		V _s -1.5	V
Lsc	Shorted Load det.	Pow. Amp. mode			0.5	Ω
		Line Driver mode			1.5	Ω

ELECTRICAL CHARACTERISTICS: (continued)

Symbol	Parameter	Test Condition	Min.	Typ.	Max.	Unit
V _O	Offset Detection	Power Amplifier in play condition AC Input signals = 0	±1.5	±2	±2.5	V
I²C BUS INTERFACE						
f _{SCL}	Clock Frequency				400	KHz
V _{IL}	Input Low Voltage				1.5	V
V _{IH}	Input High Voltage		2.3			V

I²C BUS INTERFACE

Data transmission from microprocessor to the TDA7575PD and viceversa takes place through the 2 wires I²C BUS interface, consisting of the two lines SDA and SCL (pull-up resistors to positive supply voltage must be connected).

Data Validity

As shown by fig. 1, the data on the SDA line must be stable during the high period of the clock. The HIGH and LOW state of the data line can only change when the clock signal on the SCL line is LOW.

Start and Stop Conditions

As shown by fig. 2 a start condition is a HIGH to LOW transition of the SDA line while SCL is HIGH. The stop condition is a LOW to HIGH transition of the SDA line while SCL is HIGH.

Byte Format

Every byte transferred to the SDA line must contain 8 bits. Each byte must be followed by an acknowledge bit. The MSB is transferred first.

Acknowledge

The transmitter* puts a resistive HIGH level on the SDA line during the acknowledge clock pulse (see fig.3). The receiver** the acknowledges has to pull-down (LOW) the SDA line during the acknowledge clock pulse, so that the SDA line is stable LOW during this clock pulse.

* Transmitter

- = master (μP) when it writes an address to the TDA7575PD
- = slave (TDA7575PD) when the μP reads a data byte from TDA7575PD

** Receiver

- = slave (TDA7575PD) when the μP writes an address to the TDA7575PD
- = master (μP) when it reads a data byte from TDA7575PD

Figure 1. Data Validity on the I²C BUSFigure 2. Timing Diagram on the I²C BUS

Figure 3.



1 Ohm Capability Setting

It is possible to drive 1OHM load paralleling the outputs into a single channel.

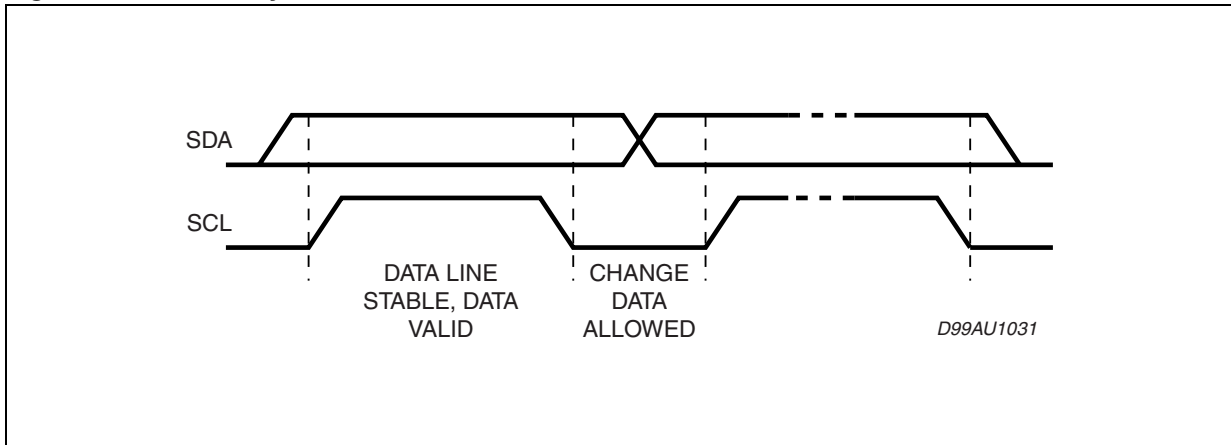
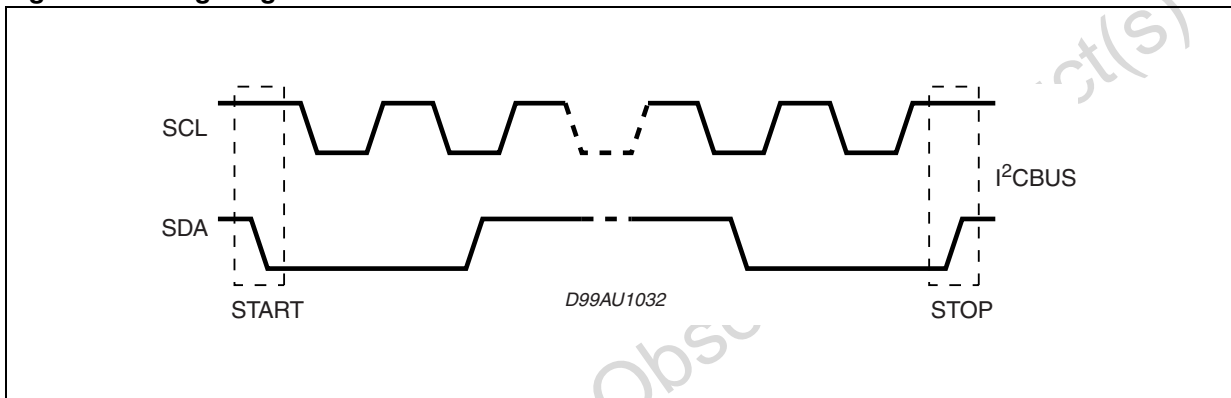
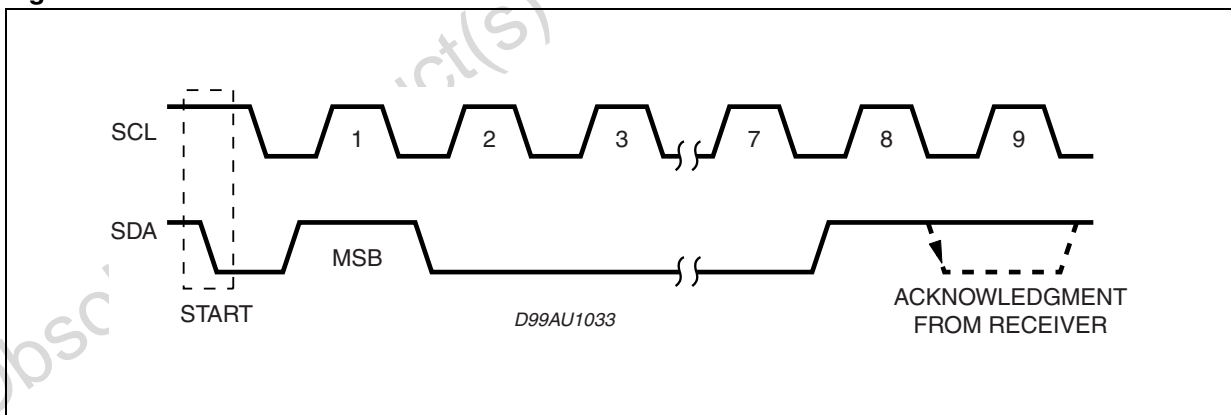
In order to implement this feature, outputs are to be connected on the board as follows:

OUT1+ (PIN35 and PIN36) shorted to OUT2+ (PIN19 and PIN20)

OUT1- (PIN28 and PIN29) shorted to OUT2- (PIN26 and PIN27).

TDA7575PD

It is recommended to minimize the impedance on the board between OUT2 and the load in order to minimize THD distortion. It is also recommended to control the maximum mismatch impedance between VCC pins (PIN21/PIN22 respect to PIN33/PIN34) and between PWGND pins (PIN24/PIN25 respect to PIN30/PIN31), mismatch that must not exceed a value of 20 mOhm.

With 1OHM feature settled the active input is IN2 (PIN17 and PIN18), therefore IN1 pins should be let floating. It is possible to set the load capability acting on 1OHM pin as follows:

1OHM PIN (PIN15) < 1.5V: two channels mode (for a minimum load of 2 OHM)

1OHM PIN (PIN15) > 2.5V: one channel mode (for 1 OHM load).

IT IS TO REMEMBER THAT 1 OHM FUNCTION IS A HARDWARE SELECTION.

Therefore it is recommended to leave 1OHM PIN floating or shorted to GND to set the two channels mode configuration, or to short 1OHM PIN to VCC to set the one channel (1OHM) configuration.

I²C Abilitation Setting

It is possible to disable the I²C interface by acting on I²C PIN (PIN16) and control the TDA7575PD by means of the usual ST-BY and MUTE pins. In order to activate or deactivate this feature, I²C PIN must be set as follows:

I²C PIN (PIN16) < 1.5V: I²C bus interface deactivated

I²C PIN (PIN16) > 2.5V: I²C bus interface activated

It is also possible to let I²C PIN floating to deactivate the I²C bus interface, or to short I²C PIN to VCC to activate it.

In particular:

I²C ENABLED: I²C pin (PIN16) > 2.5V

- STD MODE: Vstby (PIN5) > 3.5V, IB2(D1)=0
- HE MODE: Vstby (PIN5) > 3.5V, IB2(D1)=1
- PLAY MODE: Vmute (pin 4) >3.5V, IB1 (D2) = 1

The amplifier can always be switched off by putting Vstby to 0V, but with I²C enabled it can be turn on only through I²C (with Vstby>3.5V).

I²C DISABLED: I²C pin (PIN16) < 1.5V

- STD MODE: 3.5V < stby (PIN5) < 5
- HE MODE: Vstby (PIN5) > 7V
- PLAY MODE: Vmute (pin 4) >3.5V

For both STD and HE MODE the play/mute mode can be set acting on Vmute pin.

SOFTWARE SPECIFICATIONS

All the functions of the TDA7575PD are activated by I²C interface.

The bit 0 of the "ADDRESS BYTE" defines if the next bytes are write instruction (from μ P to TDA7575PD) or read instruction (from TDA7575PD to μ P).

ADDRESS SELECTION

A6	1
A5	1
A4	0
A3	1
A2	0
A1	B
A0	A
R/W	X

If R/W = 0, the μ P sends 2 "Instruction Bytes": IB1 and IB2.

IB1

D7	X
D6	Diagnostic enable (D6 = 1) Diagnostic defeat (D6 = 0)
D5	Offset Detection enable (D5 = 1) Offset Detection defeat (D5 = 0)
D4	Gain = 26dB (D4 = 0) Gain = 12dB (D4 = 1)
D3	X
D2	Mute (D2 = 0) Unmute (D2 = 1)
D1	X
D0	CD 2% (D0 = 0) CD 10% (D0 = 1)

IB2

D7	X
D6	used for testing
D5	used for testing
D4	Stand-by on - Amplifier not working - (D4 = 0) Stand-by off - Amplifier working - (D4 = 1)
D3	Power Amplifier Mode Diagnostic (D3 = 0); Line Driver Mode Diagnostic (D3 = 1)
D2	X
D1	Power amplifier working in standard mode (D1 = 0) Power amplifier working in high efficiency mode (D1 = 1)
D0	X

TDA7575PD

If R/W = 1, the TDA7575PD sends 2 "Diagnostics Bytes" to μ P: DB1 and DB2.

DB1

D7	Thermal warning (if $T_{chip} \geq 150^{\circ}\text{C}$, D7 = 1)
D6	Diag. cycle not activated or not terminated (D6 = 0) Diag. cycle terminated (D6 = 1)
D5	X
D4	Channel 1 Turn-on diagnostic (D4 = 0) Permanent diagnostic (D4 = 1)
D3	Channel 1 Normal load (D3 = 0) Short load (D3 = 1)
D2	Channel 1 Turn-on diag.: No open load (D2 = 0) Open load detection (D2 = 1) Offset diag.: No output offset (D2 = 0) Output offset detection (D2 = 1)
D1	Channel 1 No short to V_{CC} (D1 = 0) Short to V_{CC} (D1 = 1)
D0	Channel 1 No short to GND (D1 = 0) Short to GND (D1 = 1)

DB2

D7	Offset detection not activated (D7 = 0) Offset detection activated (D7 = 1)
D6	X
D5	X
D4	Channel 2 Turn-on diagnostic (D4 = 0) Permanent diagnostic (D4 = 1)
D3	Channel 2 Normal load (D3 = 0) Short load (D3 = 1)
D2	Channel 2 Turn-on diag.: No open load (D2 = 0) Open load detection (D2 = 1) Permanent diag.: No output offset (D2 = 0) Output offset detection (D2 = 1)
D1	Channel 2 No short to V_{CC} (D1 = 0) Short to V_{CC} (D1 = 1)
D0	Channel 2 No short to GND (D1 = 0) Short to GND (D1 = 1)

Examples of bytes sequence**1 - Turn-On diagnostic - Write operation**

Start	Address byte with D0 = 0	ACK	IB1 with D6 = 1	ACK	IB2	ACK	STOP
-------	--------------------------	-----	-----------------	-----	-----	-----	------

2 - Turn-On diagnostic - Read operation

Start	Address byte with D0 = 1	ACK	DB1	ACK	DB2	ACK	STOP
-------	--------------------------	-----	-----	-----	-----	-----	------

The delay from 1 to 2 can be selected by software, starting from T.B.D. ms

3a - Turn-On of the power amplifier with mute on, diagnostic defeat.

Start	Address byte with D0 = 0	ACK	IB1	ACK	IB2	ACK	STOP
			X000XXXX		XXX1XX1X		

3b - Turn-Off of the power amplifier

Start	Address byte with D0 = 0	ACK	IB1	ACK	IB2	ACK	STOP
			X0XXXXXX		XXX0XXXX		

4 - Offset detection procedure enable

Start	Address byte with D0 = 0	ACK	IB1	ACK	IB2	ACK	STOP
			XX1XX1XX		XXX1XXXX		

5 - Offset detection procedure stop and reading operation (the results are valid only for the offset detection bits (D2 of the bytes DB1, DB2, DB3, DB4).

Start	Address byte with D0 = 1	ACK	DB1	ACK	DB2	ACK	STOP
-------	--------------------------	-----	-----	-----	-----	-----	------

- The purpose of this test is to check if a D.C. offset (2V typ.) is present on the outputs, produced by input capacitor with anomalous leakage current or humidity between pins.
- The delay from 4 to 5 can be selected by software, starting from T.B.D. ms

DIAGNOSTICS FUNCTIONAL DESCRIPTION:**a) TURN-ON DIAGNOSTIC.**

It is activated at the turn-on (stand-by out) under I²C bus request. Detectable output faults are:

- SHORT TO GND
- SHORT TO Vs
- SHORT ACROSS THE SPEAKER
- OPEN SPEAKER

To verify if any of the above misconnections are in place, a subsonic (inaudible) current pulse (fig. A) is internally generated, sent through the speaker(s) and sunk back. The Turn On diagnostic status is internally stored until a successive diagnostic pulse is requested (after a I2C reading).

If the "stand-by out" and "diag. enable" commands are both given through a single programming step, the pulse takes place first (power stage still in stand-by mode, low, outputs= high impedance).

Afterwards, when the Amplifier is biased, the PERMANENT diagnostic takes place. The previous Turn On state is kept until a short appears at the outputs.

Fig A: Turn - On diagnostic: working principle

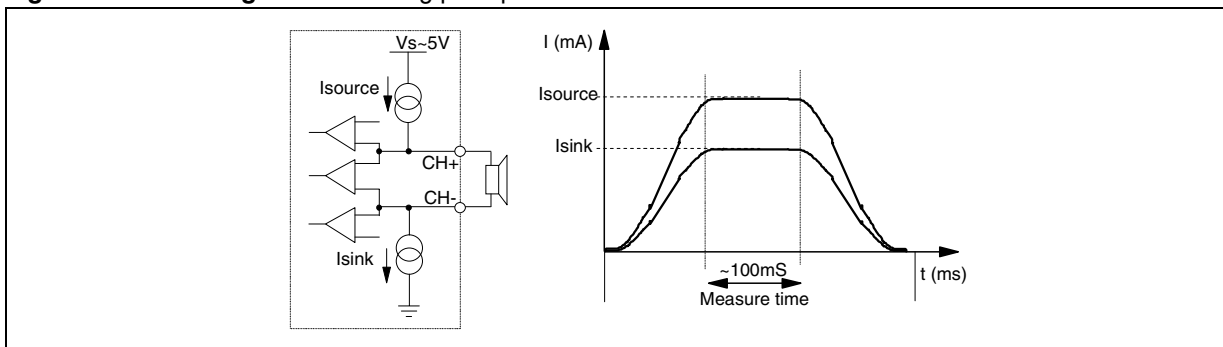

Fig. B and C show SVR and OUTPUT waveforms at the turn-on (stand-by out) with and without TURN-ON DIAGNOSTIC.

Fig B: SVR and Output behaviour

CASE 1: without turn-on diagnostic

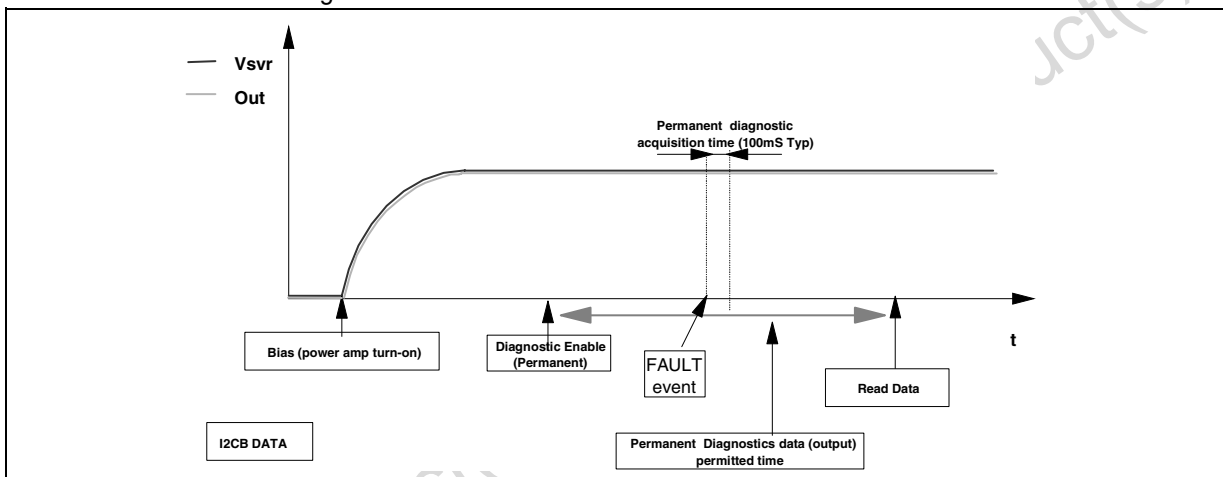
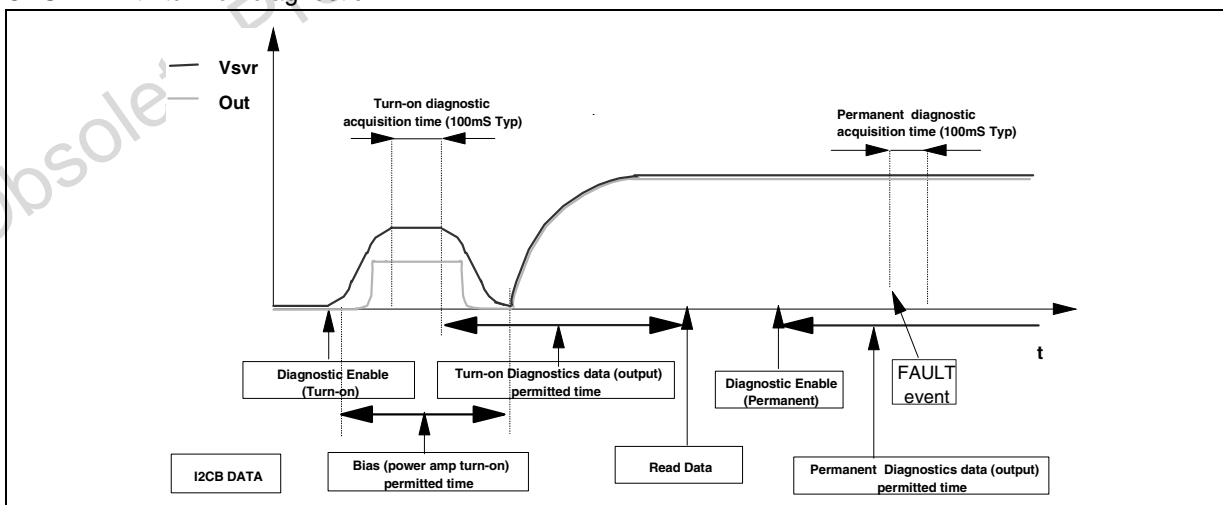
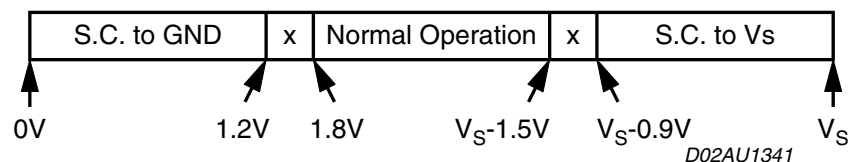

FIG. C: SVR and Output pin behaviour

CASE 2: with turn-on diagnostic



The information related to the outputs status is read and memorized at the end of the current pulse top. The acquisition time is 100 ms (typ.). No audible noise is generated in the process. As for SHORT TO GND / Vs the fault-detection thresholds remain unchanged from 26 dB to 12 dB gain setting. They are as follows:



Concerning SHORT ACROSS THE SPEAKER / OPEN SPEAKER, the threshold varies from 26 dB to 12 dB gain setting, since different loads are expected (either normal speaker's impedance or high impedance). The values in case of 26 dB gain are as follows:

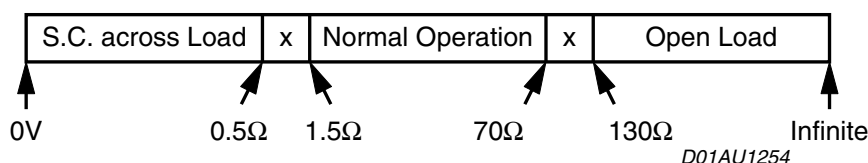

If the Line-Driver mode ($G_v = 12$ dB and Line Driver Mode diagnostic = 1) is selected, the same thresholds will change as follows:

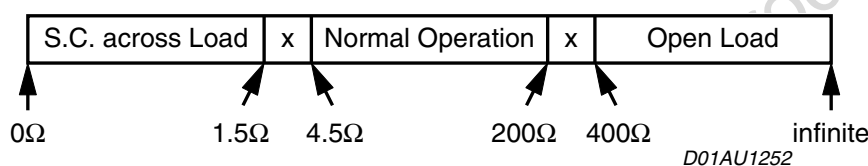

b) PERMANENT DIAGNOSTICS.

Detectable conventional faults are:

- SHORT TO GND
- SHORT TO V_S
- SHORT ACROSS THE SPEAKER

The following additional features are provided:

- OUTPUT OFFSET DETECTION

The TDA7575PD has 2 operating statuses:

1) RESTART mode. The diagnostic is not enabled. Each audio channel operates independently from each other. If any of the a.m. faults occurs, only the channel(s) interested is shut down. A check of the output status is made every 1 ms (fig. G). Restart takes place when the overload is removed.

2) DIAGNOSTIC mode. It is enabled via I²C bus and self activates if an output overload (such to cause the intervention of the short-circuit protection) occurs to the speakers outputs. Once activated, the diagnostics procedure develops as follows (fig. H):

- To avoid momentary re-circulation spikes from giving erroneous diagnostics, a check of the output status is made after 1ms: if normal situation (no overloads) is detected, the diagnostic is not performed and the channel returns back active.
- Instead, if an overload is detected during the check after 1 ms, then a diagnostic cycle having a duration of about 100 ms is started.
- After a diagnostic cycle, the audio channel interested by the fault is switched to RESTART mode. The

relevant data are stored inside the device and can be read by the microprocessor. When one cycle has terminated, the next one is activated by an I²C reading. This is to ensure continuous diagnostics throughout the car-radio operating time.

- To check the status of the device a sampling system is needed. The timing is chosen at microprocessor level (over than half a second is recommended).

Fig. G: Restart timing without Diagnostic Enable (Permanent)

Each 1mS time, a sampling of the fault is done

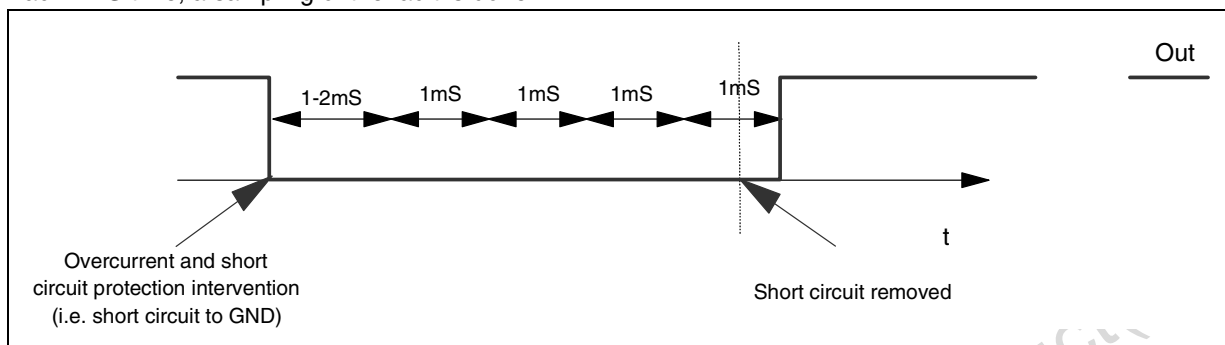
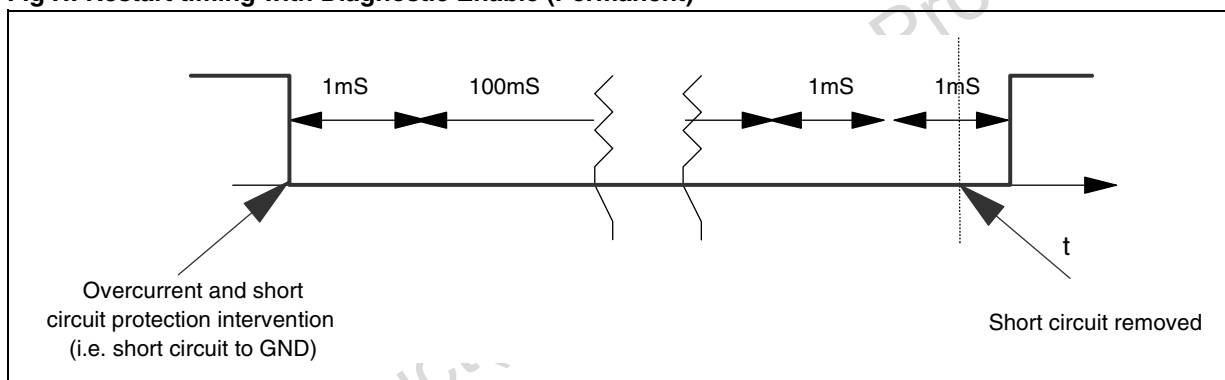

Fig H: Restart timing with Diagnostic Enable (Permanent)



OUTPUT DC OFFSET DETECTION.

Any DC output offset exceeding +/- 2 V are signalled out. This inconvenient might occur as a consequence of initially defective or aged and worn-out input capacitors feeding a DC component to the inputs, so putting the speakers at risk of overheating.

This diagnostic has to be performed with low-level output AC signal (or Vin = 0).

The test is run with selectable time duration by microprocessor (from a "start" to a "stop" command):

- START = Last reading operation or setting IB1 - D5 - (OFFSET enable) to 1
- STOP = Actual reading operation

Excess offset is signalled out if persistent throughout the assigned testing time. This feature is disabled if any overloads leading to activation of the short-circuit protection occurs in the process.

MULTIPLE FAULTS.

When more misconnections are simultaneously in place at the audio outputs, it is guaranteed that at least one of them is initially read out. The others are notified after successive cycles of I²C reading and faults removal, provided that the diagnostic is enabled. This is true for both kinds of diagnostic (Turn on and Permanent).

The table below shows all the couples of double-fault possible. It should be taken into account that a short circuit with the 4 ohm speaker unconnected is considered as double fault.

Double fault table for Turn On Diagnostic

	S. GND (sc)	S. GND (sk)	S. Vs	S. Across L.	Open L.
S. GND (sc)	S. GND	S. GND	S. Vs + S. GND	S. GND	S. GND
S. GND (sk)	/	S. GND	S. Vs	S. GND	Open L. (*)
S. Vs	/	/	S. Vs	S. Vs	S. Vs
S. Across L.	/	/	/	S. Across L.	N.A.
Open L.	/	/	/	/	Open L. (*)

S. GND (so) / S. GND (sk) in the above table make a distinction according to which of the 2 outputs is shorted to ground (test-current source side= so, test-current sink side = sk). More precisely, in both the Channels SO = CH+, and SK = CH-.

In Permanent Diagnostic the table is the same, with only a difference concerning Open Load(*) , which is not among the recognisable faults. Should an Open Load be present during the device's normal working, it would be detected at a subsequent Turn on Diagnostic cycle (i.e. at the successive Car Radio Turn on).

FAULTS AVAILABILITY

All the results coming from I²Cbus, by read operations, are the consequence of measurements inside a defined period of time. If the fault is stable throughout the whole period, it will be sent out. This is true for DC diagnostic (Turn on and Permanent), for Offset Detector.

To guarantee always resident functions, every kind of diagnostic cycles (Turn on, Permanent, Offset) will be reactivate after any I2C reading operation. So, when the micro reads the I²C, a new cycle will be able to start, but the read data will come from the previous diag. cycle (i.e. The device is in Turn On state, with a short to Gnd, then the short is removed and micro reads I2C. The short to Gnd is still present in bytes, because it is the result of the previous cycle. If another I2C reading operation occurs, the bytes do not show the short). In general to observe a change in Diagnostic bytes, two I2C reading operations are necessary.

I²C PROGRAMMING/READING SEQUENCES

A correct turn on/off sequence respectful of the diagnostic timings and producing no audible noises could be as follows (after battery connection):

- TURN-ON: (STAND-BY OUT + DIAG ENABLE) --- 500 ms (min) --- MUTING OUT
- TURN-OFF: MUTING IN --- 20 ms --- (DIAG DISABLE + STAND-BY IN)

Car Radio Installation: DIAG ENABLE (write) --- 200 ms --- I²C read (repeat until All faults disappear).

- OFFSET TEST: Device in Play (no signal) --
- OFFSET ENABLE - 30ms - I²C reading

(repeat I²C reading until high-offset message disappears).

DIM.	mm			inch		
	MIN.	TYP.	MAX.	MIN.	TYP.	MAX.
A	3.25		3.43	0.128		0.135
A2	3.1		3.2	0.122		0.126
A4	0.8		1	0.031		0.039
A5		0.2			0.008	
a1	0.030		0.040	0.0011		0.0015
b	0.22		0.38	0.008		0.015
c	0.23		0.32	0.009		0.012
D	15.8		16	0.622		0.630
D1	9.4		9.8	0.37		0.38
D2		1			0.039	
E	13.9		14.5	0.547		0.57
E1	10.9		11.1	0.429		0.437
E2			2.9			0.114
E3	5.8		6.2	0.228		0.244
E4	2.9		3.2	0.114		1.259
e		0.65			0.026	
e3		11.05			0.435	
G	0		0.075	0		0.003
H	15.5		15.9	0.61		0.625
h			1.1			0.043
L	0.8		1.1	0.031		0.043
N	10° (max)					
s	8° (max)					

- (1) "D and E1" do not include mold flash or protusions. Mold flash or protusions shall not exceed 0.15mm (0.006")
- (2) No intrusion allowed inwards the leads.

OUTLINE AND MECHANICAL DATA

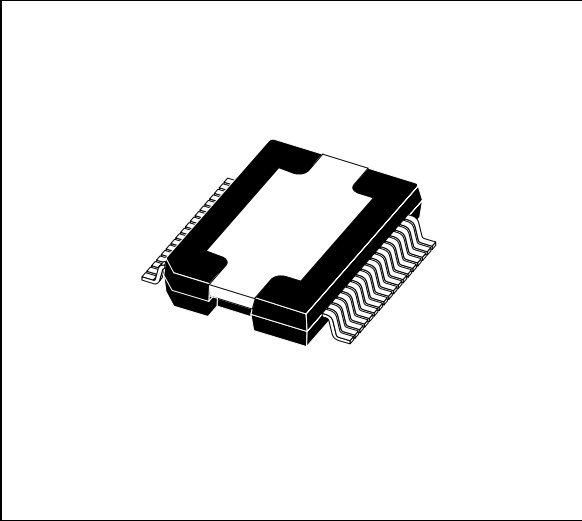

PowerSO36 (SLUG UP)

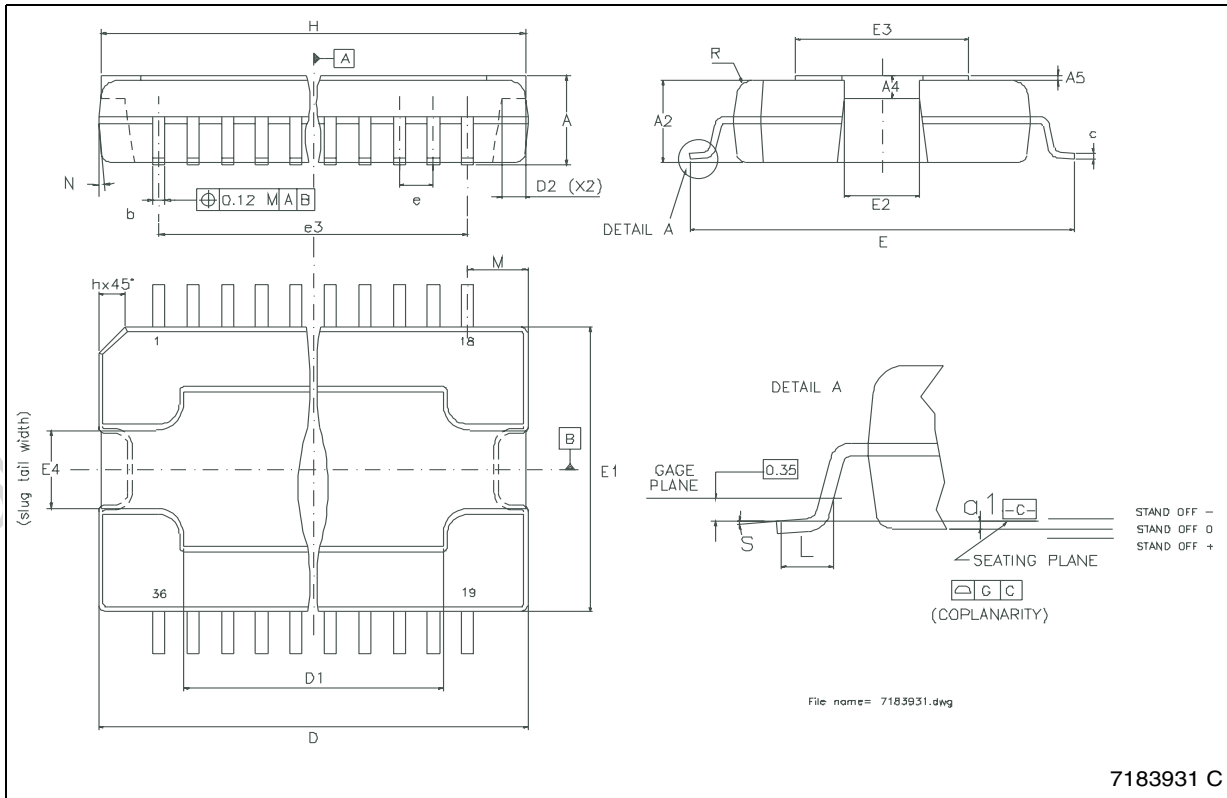

7183931 C



Information furnished is believed to be accurate and reliable. However, STMicroelectronics assumes no responsibility for the consequences of use of such information nor for any infringement of patents or other rights of third parties which may result from its use. No license is granted by implication or otherwise under any patent or patent rights of STMicroelectronics. Specifications mentioned in this publication are subject to change without notice. This publication supersedes and replaces all information previously supplied. STMicroelectronics products are not authorized for use as critical components in life support devices or systems without express written approval of STMicroelectronics.

The ST logo is a registered trademark of STMicroelectronics.
All other names are the property of their respective owners

© 2004 STMicroelectronics - All rights reserved

STMicroelectronics GROUP OF COMPANIES

Australia - Belgium - Brazil - Canada - China - Czech Republic - Finland - France - Germany - Hong Kong - India - Israel - Italy - Japan -
Malaysia - Malta - Morocco - Singapore - Spain - Sweden - Switzerland - United Kingdom - United States

www.st.com

